



## 320W Single Output with PFC Function

# SP-320 series



### ■ Features :

- Universal AC input / Full range
- Built-in active PFC function, PF>0.95
- Protections: Short circuit / Overload / Over voltage / Over temperature
- Forced air cooling by built-in DC Fan
- Built-in fan speed control
- Fixed switching frequency at 100KHz
- 3 years warranty



### SPECIFICATION

MODEL		SP-320-3.3	SP-320-5	SP-320-7.5	SP-320-12	SP-320-13.5	SP-320-15	SP-320-24	SP-320-27	SP-320-36	SP-320-48	
OUTPUT	DC VOLTAGE	3.3V	5V	7.5V	12V	13.5V	15V	24V	27V	36V	48V	
	RATED CURRENT	55A	55A	40A	25A	22A	20A	13A	11.7A	8.8A	6.7A	
	CURRENT RANGE	0 ~ 60A	0 ~ 55A	0 ~ 40A	0 ~ 25A	0 ~ 22A	0 ~ 20A	0 ~ 13A	0 ~ 11.7A	0 ~ 8.8A	0 ~ 6.7A	
	RATED POWER	181.5W	275W	300W	300W	297W	300W	312W	315.9W	316.8W	321.6W	
	RIPPLE & NOISE (max.) Note.2	150mVp-p	150mVp-p	150mVp-p	150mVp-p	150mVp-p	150mVp-p	150mVp-p	200mVp-p	220mVp-p	240mVp-p	
	VOLTAGE ADJ. RANGE	3.14 ~ 3.63V	4.5 ~ 5.5V	6 ~ 9V	10 ~ 13.2V	12 ~ 15V	13.5 ~ 18V	20 ~ 26.4V	26 ~ 31.5V	32.4 ~ 39.6V	41 ~ 56V	
	VOLTAGE TOLERANCE Note.3	±1.0%	±2.0%	±2.0%	±1.0%	±1.0%	±1.0%	±1.0%	±1.0%	±1.0%	±1.0%	
	LINE REGULATION	±0.5%	±0.5%	±0.5%	±0.3%	±0.3%	±0.3%	±0.2%	±0.2%	±0.2%	±0.2%	
	LOAD REGULATION	±1.5%	±1.0%	±1.0%	±0.5%	±0.5%	±0.5%	±0.5%	±0.5%	±0.5%	±0.5%	
	SETUP, RISE TIME	800ms, 50ms/230VAC      2500ms, 50ms/115VAC at full load										
HOLD UP TIME (Typ.)	16ms/230VAC      16ms/115VAC at full load											
INPUT	VOLTAGE RANGE Note.5	88 ~ 264VAC		124 ~ 370VDC								
	FREQUENCY RANGE	47 ~ 63Hz										
	POWER FACTOR (Typ.)	PF>0.95/230VAC			PF>0.98/115VAC at full load							
	EFFICIENCY (Typ.)	74%	79%	83%	86%	86%	86%	87%	88%	87%	89%	
	AC CURRENT (Typ.)	115VAC	2.5A	5A								
		230VAC	1.5A	2.5A								
	INRUSH CURRENT (Typ.)	20A/115VAC		40A/230VAC								
LEAKAGE CURRENT	<1mA / 240VAC											
PROTECTION	OVERLOAD	105 ~ 135% rated output power Protection type : Hiccup mode, recovers automatically after fault condition is removed										
	OVER VOLTAGE	3.8 ~ 4.5V	5.75 ~ 6.75V	9.4 ~ 10.9V	13.8 ~ 16.2V	15.5 ~ 18.2V	18 ~ 21V	27.6 ~ 32.4V	33.7 ~ 39.2V	45 ~ 52.5V	57.6 ~ 67.2V	
		Protection type : Shut down o/p voltage, re-power on to recover										
OVER TEMPERATURE	80°C ±5°C (70°C ±5°C 3.3V,5V only) (TSW1 : detect on heatsink of power transistor) Protection type : Shut down o/p voltage, recovers automatically after temperature goes down											
ENVIRONMENT	WORKING TEMP.	-20 ~ +65°C (Refer to output load derating curve)										
	WORKING HUMIDITY	20 ~ 90% RH non-condensing										
	STORAGE TEMP., HUMIDITY	-40 ~ +85°C, 10 ~ 95% RH										
	TEMP. COEFFICIENT	±0.03%/°C (0 ~ 50°C)										
	VIBRATION	10 ~ 500Hz, 2G 10min./1cycle, 60min. each along X, Y, Z axes										
SAFETY & EMC (Note 4)	SAFETY STANDARDS	UL60950-1, TUV EN60950-1, CCC GB4943(except for 3.3V, 48V) approved										
	WITHSTAND VOLTAGE	I/P-O/P:3KVAC I/P-FG:1.5KVAC O/P-FG:0.5KVAC										
	ISOLATION RESISTANCE	I/P-O/P, I/P-FG, O/P-FG:100M Ohms / 500VDC / 25°C / 70% RH										
	EMI CONDUCTION & RADIATION	Compliance to EN55022 (CISPR22) Class B										
	HARMONIC CURRENT	Compliance to EN61000-3-2,-3										
	EMS IMMUNITY	Compliance to EN61000-4-2,3,4,5,6,8,11; ENV50204, EN55024, light industry level, criteria A										
OTHERS	MTBF	207K hrs min. MIL-HDBK-217F (25°C)										
	DIMENSION	215*115*50mm (L*W*H)										
	PACKING	1.1Kg; 12pcs/14Kg/0.92CUFT										
NOTE	<ol style="list-style-type: none"> <li>1. All parameters NOT specially mentioned are measured at 230VAC input, rated load and 25°C of ambient temperature.</li> <li>2. Ripple &amp; noise are measured at 20MHz of bandwidth by using a 12" twisted pair-wire terminated with a 0.1uf &amp; 47uf parallel capacitor.</li> <li>3. Tolerance : includes set up tolerance, line regulation and load regulation.</li> <li>4. The power supply is considered a component which will be installed into a final equipment. The final equipment must be re-confirmed that it still meets EMC directives. For guidance on how to perform these EMC tests, please refer to "EMI testing of component power supplies." (as available on <a href="http://www.meanwell.com">http://www.meanwell.com</a>)</li> <li>5. Derating may be needed under low input voltages. Please check the derating curve for more details.</li> </ol>											

**Mechanical Specification**

Case No. 912G Unit:mm

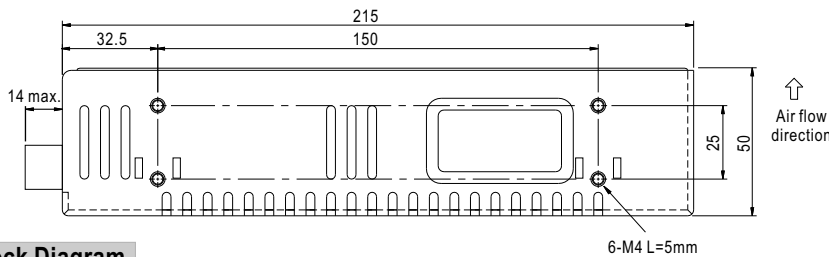
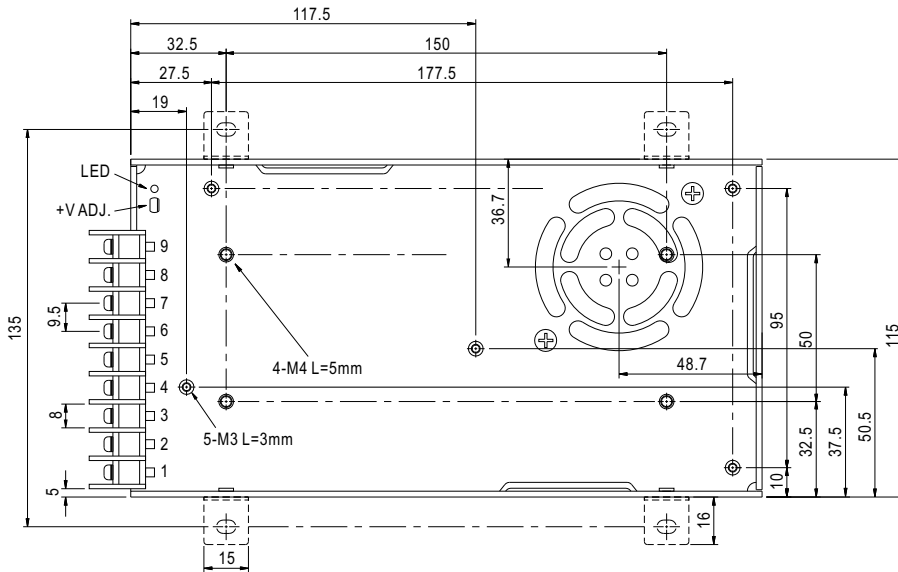

Terminal Pin No. Assignment :

Pin No.	Assignment	Pin No.	Assignment
1	AC/L	4~6	DC OUTPUT -V
2	AC/N	7~9	DC OUTPUT +V
3	FG $\perp$		

**Block Diagram**

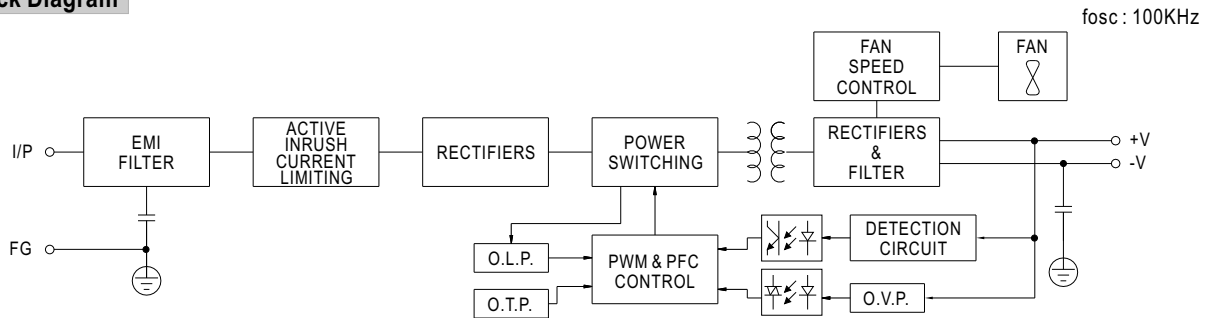

**Derating Curve**

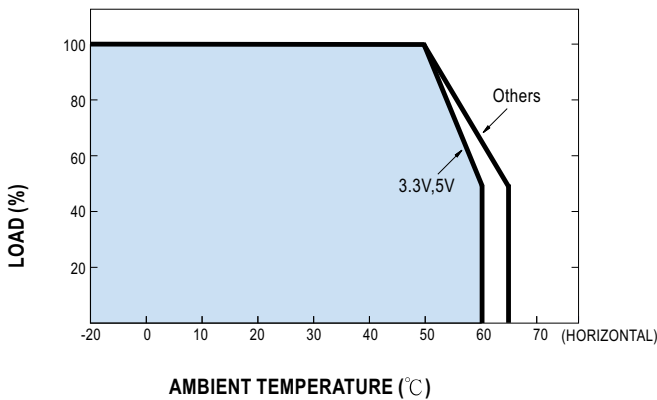

**Static Characteristics**

