



600W Single Output with PFC Function

**HRP-600N** series



AS/NZS 62368.1



UL62368-1



EN62368-1



TPTC004



IEC62368-1



Automate



Industrial



Network



Telecom



Security

## ■ Features

- Universal AC input / Full range
- Built-in active PFC function, PF>0.94
- 200% peak power capability
- High efficiency up to 89%
- Withstand 300VAC surge input for 5 seconds
- Protections: Short circuit / Overload / Over voltage / Over temperature
- Built-in cooling fan ON-OFF control
- Built-in DC OK signal
- Built-in remote sense function
- 5 years warranty

## ■ Applications

- Industrial automation machinery
- Industrial control system
- Mechanical and electrical equipment
- Diagnostic or biological facilities
- Test or measurement systems
- Telecommunication equipment

## ■ Description

HRP-600N is a 600W single output type AC/DC power supply. This series operates for 85~264VAC input voltage and offers the models with the DC output mostly demanded from the industry. Each model is cooled by the built-in fan with fan ON-OFF control, working for the temperature up to 70°C. Moreover, HRP-600N provides 200% short-duration peak power for motor applications and electromechanical loads requiring much higher power during start-up.

## ■ Model Encoding

HRP - 600N - 24

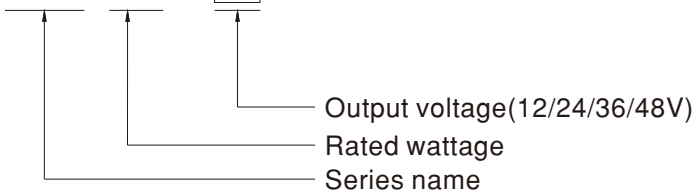



SPECIFICATION

MODEL		HRP-600N-12	HRP-600N-24	HRP-600N-36	HRP-600N-48	
OUTPUT	DC VOLTAGE	12V	24V	36V	48V	
	RATED CURRENT	53A	27A	17.5A	13A	
	CURRENT RANGE	0 ~ 53A	0 ~ 27A	0 ~ 17.5A	0 ~ 13A	
	RATED POWER	636W	648W	630W	624W	
	RIPPLE & NOISE (max.) Note.2	200mVp-p	150mVp-p	200mVp-p	240mVp-p	
	VOLTAGE ADJ. RANGE	10.2 ~ 13.8V	21.6 ~ 28.8V	28.8 ~ 39.6V	40.8 ~ 55.2V	
	VOLTAGE TOLERANCE Note.3	± 1.0%	± 1.0%	± 1.0%	± 1.0%	
	LINE REGULATION	± 0.3%	± 0.2%	± 0.2%	± 0.2%	
	LOAD REGULATION	± 0.5%	± 0.5%	± 0.5%	± 0.5%	
	SETUP, RISE TIME	1800ms, 50ms/230VAC    3600ms, 50ms/115VAC at full load				
HOLD UP TIME (Typ.)	16ms/230VAC    16ms/115VAC at full load					
INPUT	VOLTAGE RANGE Note.4	85 ~ 264VAC    120 ~ 370VDC				
	FREQUENCY RANGE	47 ~ 63Hz				
	POWER FACTOR (Typ.)	PF>0.94/230VAC    PF>0.98/115VAC at full load				
	EFFICIENCY (Typ.)	88%	88%	89%	89%	
	AC CURRENT (Typ.)	7.6A/115VAC	3.6A/230VAC			
	INRUSH CURRENT (Typ.)	35A/115VAC	70A/230VAC			
LEAKAGE CURRENT	<1.5mA / 240VAC					
PROTECTION	OVERLOAD	Normally works within 105 ~ 200% rated output power for more than 5 seconds and then shut down o/p voltage, re-power on to recover				
		Constant current limiting for output power >220% rated for more than 5 seconds and then shut down o/p voltage, re-power on to recover				
	OVER VOLTAGE	14.4 ~ 16.8V	30 ~ 34.8V	41.4 ~ 48.6V	57.6 ~ 67.2V	
	OVER TEMPERATURE	Protection type : Shut down o/p voltage, re-power on to recover Shut down o/p voltage, recovers automatically after temperature goes down				
FUNCTION	DC OK SIGNAL	PSU turn on : 3.3 ~ 5.6V ; PSU turn off : 0 ~ 1V				
	FAN CONTROL (Typ.)	Load 35 ± 15% or RTH2 ≥ 50°C Fan on				
ENVIRONMENT	WORKING TEMP.	-40 ~ +70°C (Refer to "Derating Curve")				
	WORKING HUMIDITY	20 ~ 90% RH non-condensing				
	STORAGE TEMP., HUMIDITY	-40 ~ +85°C, 10 ~ 95% RH non-condensing				
	TEMP. COEFFICIENT	± 0.03%/°C (0 ~ 50°C)				
	VIBRATION	10 ~ 500Hz, 5G 10min./1cycle, 60min. each along X, Y, Z axes				
	OPERATING ALTITUDE Note.6	5000 meters				
SAFETY & EMC (Note 5)	SAFETY STANDARDS	UL62368-1, TUV EN62368-1, EAC TP TC 004, AS/NZS 62368.1 approved				
	WITHSTAND VOLTAGE	I/P-O/P:3KVAC    I/P-FG:2KVAC    O/P-FG:0.5KVAC				
	ISOLATION RESISTANCE	I/P-O/P, I/P-FG, O/P-FG:100M Ohms / 500VDC / 25°C / 70% RH				
	EMC EMISSION	Parameter	Standard		Test Level / Note	
		Conducted	EN55032		Class B	
		Radiated	EN55032		Class B	
		Harmonic current	EN61000-3-2		Class A	
		Voltage Flicker	EN61000-3-3		-----	
	EMC IMMUNITY	EN55035 , EN61000-6-2(EN50082-2)				
		Parameter	Standard		Test Level / Note	
		ESD	EN61000-4-2		Level 3, 8KV air; Level 2, 4KV contact	
		RF field	EN61000-4-3		Level 3, 10V/m	
		EFT/ Burst	EN61000-4-4		Level 3, 2KV	
		Surge	EN61000-4-5		Level 4, 4KV/Line-FG; 2KV/Line-Line	
Conducted		EN61000-4-6		Level 3, 10V		
Magnetic Field		EN61000-4-8		Level 4, 30A/m		
Voltage Dips and Interruptions	EN61000-4-11		95% dip 0.5 periods, 30% dip 25 periods, 95% interruptions 250 periods			
OTHERS	MTBF	452.04K hrs min.    Telcordia TR/SR-332 (Bellcore) ;    191.26K hrs min.    MIL-HDBK-217F (25°C)				
	DIMENSION	218*105*61.5mm (L*W*H)				
	PACKING	1.39Kg;8pcs/12.1Kg/1.58CUFT				
NOTE	<p>1. All parameters NOT specially mentioned are measured at 230VAC input, rated load and 25°C of ambient temperature.</p> <p>2. Ripple &amp; noise are measured at 20MHz of bandwidth by using a 12" twisted pair-wire terminated with a 0.1uf &amp; 47uf parallel capacitor.</p> <p>3. Tolerance : includes set up tolerance, line regulation and load regulation.</p> <p>4. Derating may be needed under low input voltages. Please check the derating curve for more details.</p> <p>5. The power supply is considered a component which will be installed into a final equipment. All the EMC tests are been executed by mounting the unit on a 360mm*360mm metal plate with 1mm of thickness. The final equipment must be re-confirmed that it still meets EMC directives. For guidance on how to perform these EMC tests, please refer to "EMI testing of component power supplies." (as available on <a href="http://www.meanwell.com">http://www.meanwell.com</a>)</p> <p>6. The ambient temperature derating of 3.5°C/1000m with fanless models and of 5°C/1000m with fan models for operating altitude higher than 2000m(6500ft).</p>					

## Block Diagram

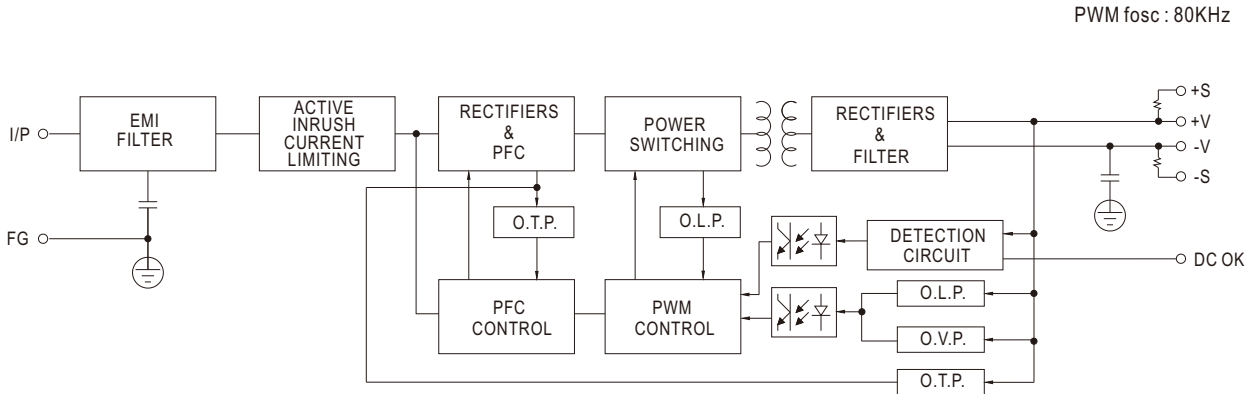

## Derating Curve

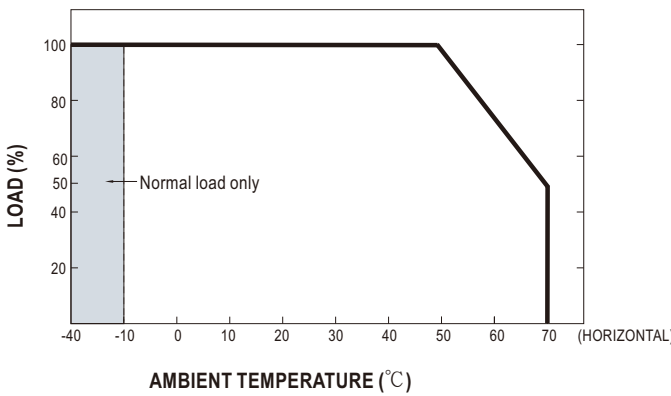

## Output Derating VS Input Voltage

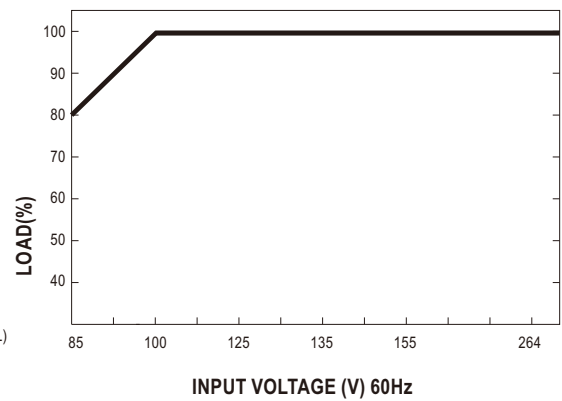

## Function Manual

### 1. Remote Sense

The remote sensing compensates voltage drop on the load wiring up to 0.5V.

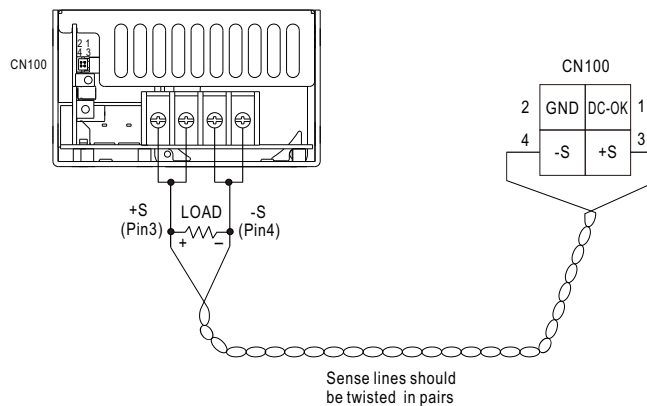

Fig 1.1

### 2.DC-OK Signal

DC-OK signal is a TTL level signal. High when PSU turns on.

Between DC-OK(pin3) and GND(pin5)	Output Status
3.3 ~ 5.6V	ON
0 ~ 1V	OFF

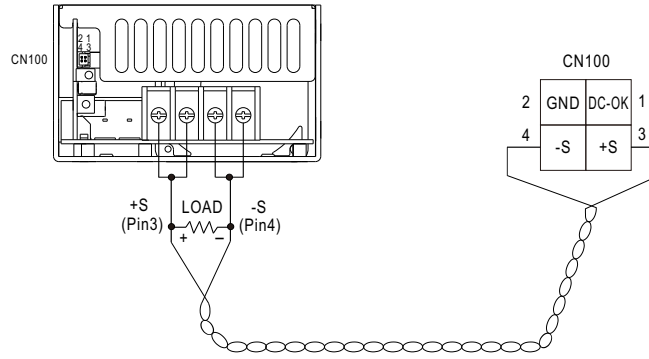

Fig 2.1

Sense lines should be twisted in pairs

### 3.Peak Power

$$P_{av} = \frac{P_{pk} \times t + P_{npk} \times (T-t)}{T} \leq P_{rated}$$

$$\text{Duty} \frac{t}{T} \times 100\% \leq 35\%$$

$$t \leq 5 \text{ sec}$$

$P_{av}$  : Average output power (W)

$P_{pk}$  : Peak output power (W)

$P_{npk}$  : Non-peak output power(W)

$P_{rated}$  : Rated output power(W)

$t$  : Peak power width(sec)

$T$  : Period(sec)

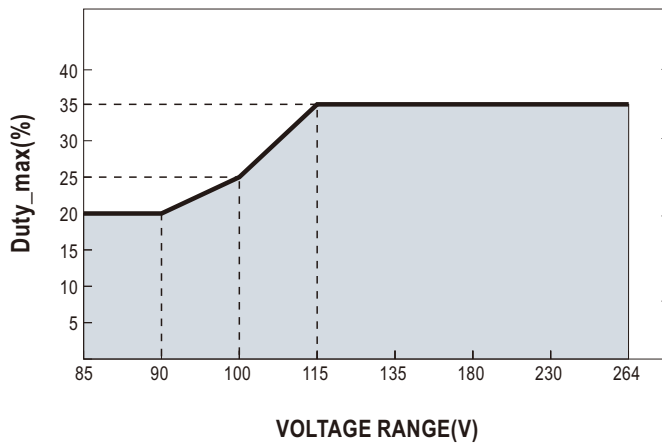
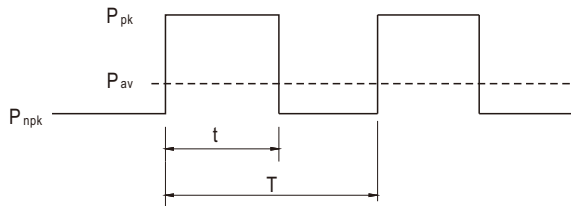

**For example (12V model) :**

$V_{in} = 100V$      $\text{Duty\_max} = 25\%$

$P_{av} = P_{rated} = 636W$

$P_{pk} = 200\% P_{rated} = 1272W$

$t \leq 5 \text{ sec}$

$T \geq 20 \text{ sec}$

$$P_{av} = \frac{P_{pk} \times t + P_{npk} \times (T-t)}{T} = \frac{1272 \times 5 + P_{npk} (20-5)}{20} \leq 636W$$

$$P_{npk} \leq 424W$$

## Mechanical Specification

Case No. 977A Unit:mm

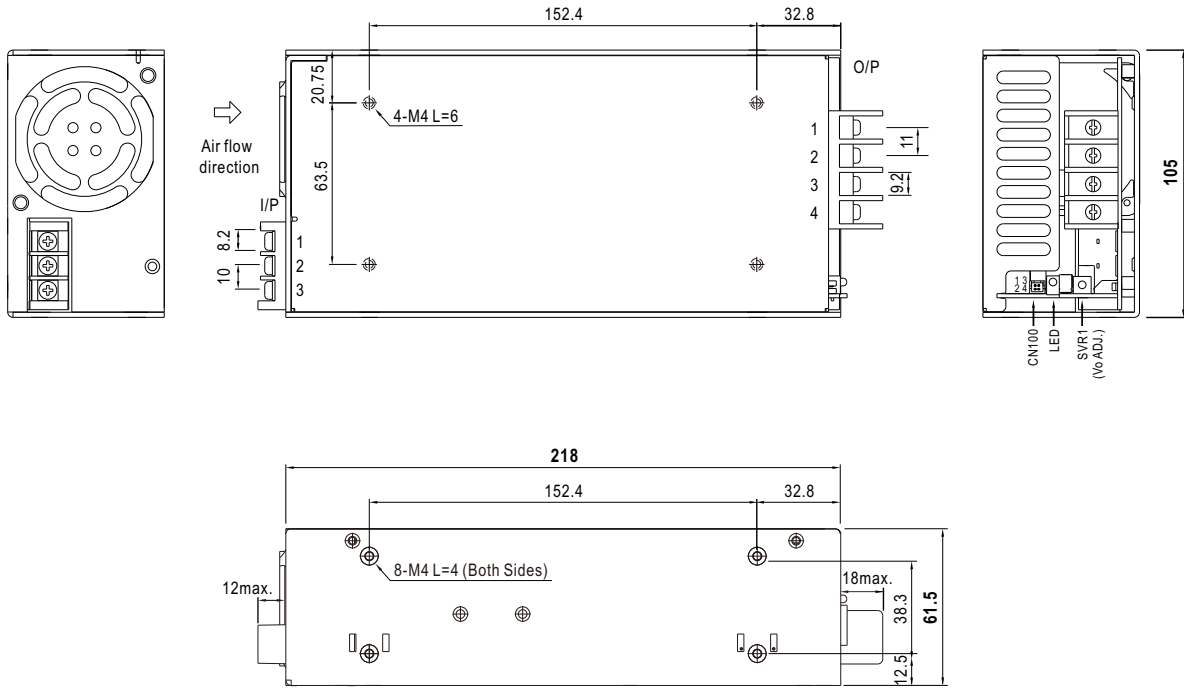

AC Input Terminal Pin No. Assignment

Pin No.	Assignment
1	AC/L
2	AC/N
3	FG $\perp$

DC Output Terminal Pin No. Assignment

Pin No.	Assignment
1~2	-V
3~4	+V

Connector Pin No. Assignment(CN100) : HRS DF11-4DP-2DS or equivalent

Pin No.	Assignment	Mating Housing	Terminal
1	DC-OK	HRS DF11-4DS or equivalent	HRS DF11-4SC or equivalent
2	GND		
3	+S		
4	-S		

## Installation Manual

Please refer to : <http://www.meanwell.com/manual.html>