

Country of Origin : China  
 Operating Temperature : 0~40 [°C]  
 Dimension : 93.5 x 46 x 37.7 [mm]  
 Certified AC Plugs: EU, UK, USA/Japan, Australia, China  
 Efficiency level (ErP) :

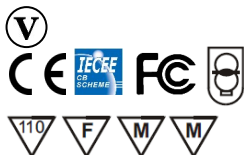

**Features:**

Wall-mount LED Driver with Exchangeable AC Plugs.	For LED applications use only
Wide range Input (90 ~ 264) VAC / (47 ~ 63) Hz.	RoHS conform
Customer can choose one or more certified plugs Wxx*(W2E, W2, W3U, W2A, W2C).	
Output connector: standard: 2.1 x 5.5 x 11mm or customer requirement.	

**Specification:**

	Model	Voltage DC [V]	Loading [A]	Line/Road regulation [%]	Over Current [A]	Over Voltage [V]	Max. Power [W]	Ripple / Noise [mV] p-p	Connector UL approved [mm]
ErP V.	SYL1460-2412-Wxx*	12	0.01~2.00	5	2.05 ~ 3.5	< 20	24	250	2.1x5.5x11
	SYL1460-2415-Wxx*	15	0.01~1.60	5	1.65 ~ 3.0	< 25	24	250	2.1x5.5x11
	SYL1460-2424-Wxx*	24	0.01~1.00	5	1.05 ~ 2.0	< 40	24	300	2.1x5.5x11
*Wxx	Possible to order with	Wxx =W2E - Europe   W2 - USA,Canada   W3U - UK   W2A - Australia   W2C - China							
INPUT	Voltage	(90 ~ 264) VAC							
	Frequency	(47 ~ 63) Hz							
	Current	0.5A rms@ AC low line input and DC output full load							
	Inrush Current (cold start)	60Amax. @ LED Driver cold start, ambient temperature 25°C @230Vac nominal AC input.							
	Leakage current	0.25 mA max.							
PROTECTION	Over Current	The LED Driver will self-protect any output to ground, And auto recovery when abnormal circuit faults remove.							
	Over Voltage	The LED Driver will not be auto recovered when faults remove							
	Short Circuit	Is defined as any output impedance of less than 0.1Ω. The LED Driver will be auto recovered when short circuit faults remove.							
OTHERS	Efficiency (typical)	≥82.1% @ full load according upon spec							
	Power factor	0.9 min At AC nominal input @ output full load							
	Standby Power	0.3W rms max. At AC nominal input @ output min load							
	Cooling	Free air convection							
	M.T.B.F.	50K hours full rated load operation at 25°C, according to the MIL-HDBK-217F.							
	HI-POT	IEC 320 2pin primary to secondary 3750Vac 10mA 1min							
ENVIRONMENT	Temperature	Operating: (0 ~ 40)°C / Storage: (-20 ~ 85)°C							
	Humidity	Operating: 8% ~ 90% RH non condensing / Storage: 5% ~ 95% RH non condensing							
CONNECTION	Input	Plugs: EU, UK, US, AUS, China (exchangeable)							
	Output	Plug standard center '+' or customer requirement // Cable length 1,8m							
<b>SAFETY</b>	<b>CE   MM Mark   F Mark   CB   FCC   EN61347-2-13</b>								
EMC	EMI	EN 55015:2006+A2:2009   EN 61000-3-2:2006/A2:2009   EN 61000-3-3:2013							
	EMS	EN 61547:2009   EN 61000-4-2: 2009   EN 61000-4-3: 2006/A2:2010   EN 61000-4-4: 2004/A1:2012   EN 61000-4-5: 2006   EN 61000-4-6: 2009   EN 61000-4-8: 2010   EN 61000-4-11: 2004							
WEIGHT	1pc	N.W.: 156 g/pc + plug							
PACKING	Box	0.42 x 0.38 x 0.27 [m]							G.W.: - kg/box
		63pcs / 1box – provide without plugs / plugs are separately							

**Mechanical case specification:**

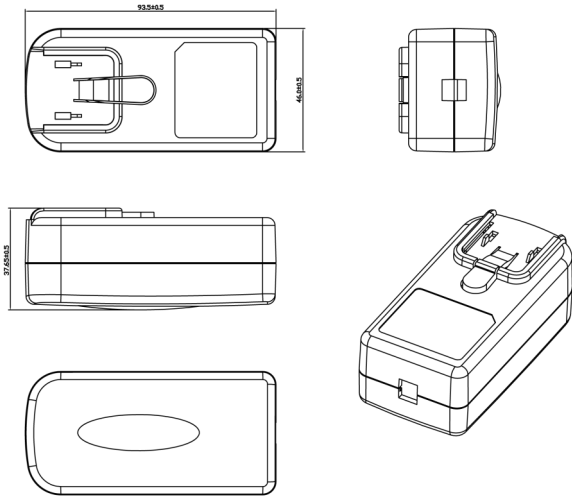

**Mechanical specification (country housing):**

US / Japan type (W2)

UK type (W3U)

Europe type (W2E)

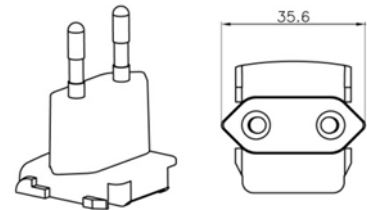
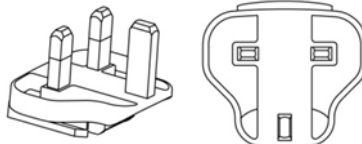
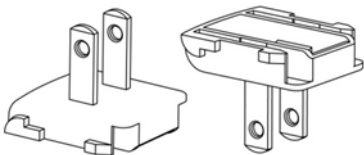

Australia type (W2A)

China type (W2C)

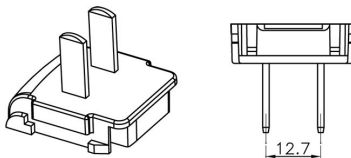
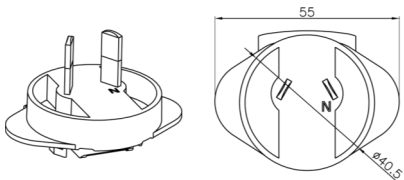

**Cable specification:**

