

Country of Origin : China
 Operating Temperature : 0~40 [°C]
 Efficiency level (ErP) : VI



Approvals / Marks :



Specifications

Model	Voltage DC [V]	Loading [A]	Max. Power [W]	Ripple / Noise [mV] p-p	Connector [mm]
SYS1638-0605-Wxx	5	0~1.2	6	250	2.1x5.5x11
SYS1638-0605-Wxx	5	0~1.2	6	250	Mini USB
SYS1638-0605-Wxx	5	0~1.2	6	250	Micro USB
SYS1638-0605-Wxx	5	0~1.2	6	250	USB inlet
SYS1638-0612-Wxx	12	0~0.5	6	200	2.1x5.5x11

Features:

Certified plugs Wxx = W2E - Europe | W3U - England | W2 - USA, Canada, Japan, Taiwan | W2C - China | W2K - Korea
 Output connector: standard: 2.1 x 5.5 x 11mm or customer requirement | Regulated Output With Low Ripple Noise | Safety Agency Requirements and EMI/EMS Certified
 Private Label Marking Available | Modified and Custom Design Available | 2 Years Warranty

OUTPUT		CE	
Turn delay	3000ms max@AC low line input@output full load	EMC	2014/30/EU
Hold up time	5ms min@AC nominal input@output full load	LVD	2014/35/EU EN 62368-1
Efficiency (Normal)	>79.03%@115v/60HZ,230V/50HZ input & Full load	SAFETY	
Transient response (dv,tmax)	0.6V dv max At AC nominal input loading from 20%load to 80% load	cULus / FCC / CB / CE / GS	
	Dynamic rise time 10 us max,duty 40ms max,Dynamic load step is slew rate of 0.5A/us	OTHERS	
Power out.Limit	6W	Dielectric Strength(Hi-pot)	Primary to Secondary:4000VAC 10mA/60S
Burn in limit	Full load 2 Hours	M.T.B.F	500,000 Calculated Hours at 25°C, by Telcordia SR-332
Power consumption	0.075W max. At AC nominal input@output min load	Cable Length	1500mm (5 feet) standard cable or as required
INPUT		PLD (power line disturbance)	Line power surge Line voltage SAG-more info on request
Voltage	(90~264)VAC	Cooling method	Natural Convection Cooling
Frequency	(47~63)hz	Housing material	PC
Current	0.5A rms@AC low line input and DC output full load	Temperature coefficient:	< ±0.5% / °C
Inrush Surge Current (cold start)	40/60A max@power supply cold start,ambient temperature 25°C @115Vac/230Vac nominal AC input	ENVIRONMENT	
leakage current	0.25mA Max	Temperature	Operating: 0~40°C / Storage: -20~85°C
PROTECTION		Humidity	Operating: 8%~90%RH / Storage: 5%~95% RH non condens-ing
Over current/ Short protection	The power supply will be auto recovered when over current or short circuit faults remove (fold back). Is defined as any output impedance of less than 0.1Ω. The power supply will be auto recovered when short circuit faults remove	WEIGHT	
Over Voltage	The power supply will not be auto recovered when faults remove 110%-150%. (Voltage limit)	1PC	NW: 79g/pc
Input protection	F1 1A/250V Fuse The power supply shall be protected against power line surges and any abnormal condition		GW: 95g/pc
No Load protection	The power supply is provided with no load operation to prevent the power supply and system from damage.	PACKING	
Protection class	II	PE plastic bag	100 pcs /1 box

Mechanical case specification:

1) SYS1638-series (EU)

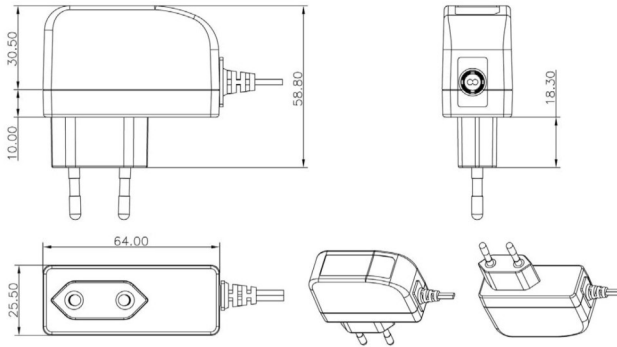

2) SYS1638-series (EU) / USB inlet

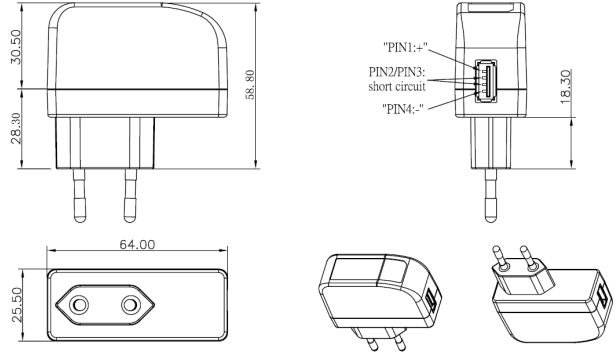

Mechanical specification (country housing):

US / Japan type (W2)

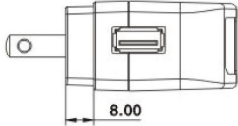

UK type (W3U)

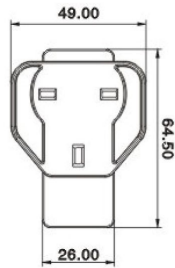

Europe type (W2E)

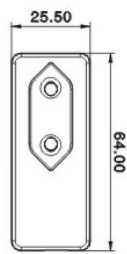

China type (W2C)

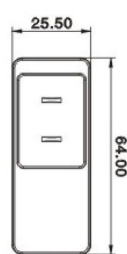

Korea (type W2K)

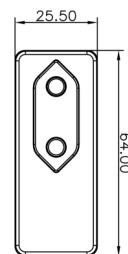

Cable specification:

a) 2.1*5.5*11 (2468#24*2C / 5FT)

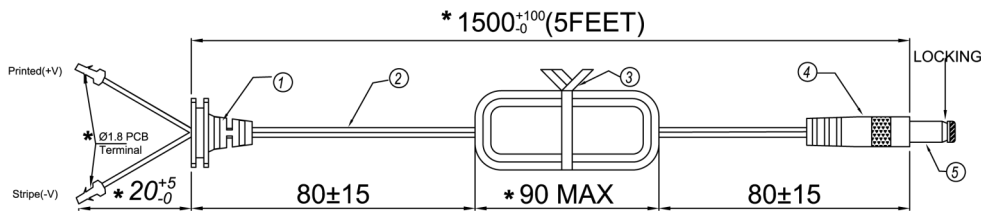

b) mini USB (1185#22*1C+SHIELD / 6FT)

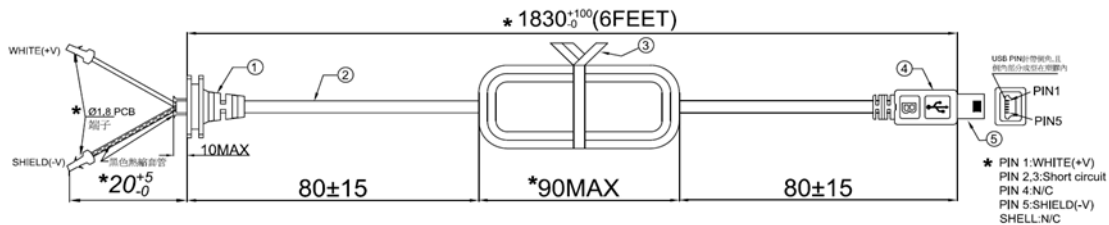

c) micro USB (1185#22*1C+SHIELD / 6FT)

