



GREEN MODE

RoHS

Country of Origin : China  
 Operating Temperature : 0~40 [°C]  
 Dimension : 80x 58x 39 [mm]  
 Certified AC Plugs: EU, UK, USA/Japan/Taiwan, Aus, China, Korea  
 Efficiency level (ErP) : VI



Approvals / Marks :



**Specifications**

Model	Voltage DC [V]	Loading [A]	Max. Power [W]	Ripple / Noise [mV] p-p	Connector [mm]
SYS1588-3005-Wxx*	5	0~6	30	120	2.1x5.5x11
SYS1588-3609-Wxx*	9	0~4	36	120	2.1x5.5x11
SYS1588-4012-Wxx*	12	0~3.3	40	200	2.1x5.5x11
SYS1588-4015-Wxx*	15	0~2.6	40	200	2.1x5.5x11
SYS1588-4018-Wxx*	18	0~2.2	40	240	2.1x5.5x11
SYS1588-4024-Wxx*	24	0~1.6	40	240	2.1x5.5x11
SYS1588-4048-Wxx*	48	0~0.8	40	400	2.1x5.5x11

**Features:**

Certified plugs Wxx = W2E - Europe | W3U - England | W2 - USA, Canada, Japan,Taiwan | W2A - Australia | W2C - China | W2K - Korea  
 Output connector: standard: 2.1 x 5.5 x 11mm or customer requirement | Regulated Output With Low Ripple Noise | Safety Agency Requirements and EM/EMS Certified  
 Private Label Marking Available | Modified and Custom Design Available | 2 Years Warranty

OUTPUT	
Turn delay	5000ms max@AC low line input@output full load
Hold up time	8ms min@AC nominal input@output full load
Efficiency (Normal)	>87%@115v/60HZ,230V/50HZ input &Full load
Transient response (dv,tmax)	0.4V dv max At AC nominal input loading from 20%load to 80% load 16ms tmax Dynamic rise time 10 us max,duty 40ms max,Dynamic load step is slew rate of 0.5A/us
Power out.Limit	40W
Burn in limit	Full load 2 Hours
Power consumption	0.1W max. At AC nominal input@output min load
INPUT	
Voltage	(90~264)VAC
Frequency	(47~63)hz
Current	1.5A rms@AC low line input and DC output full load
Inrush Surge Current (cold start)	40/60A max@power supply cold start,ambient temperature 25°C @115Vac/230Vac nominal AC input
leakage current	0.25mA Max
PROTECTION	
Over current/ Short protection	The power supply will be auto recovered when over current or short circuit faults remove (fold back). Is defined as any output impedance of less than 0.1Ω.The power supply will be auto recovered when short circuit faults remove
Over Voltage	The power supply will not be auto recovered when faults remove 110%-150%. (Voltage limit)
Input protection	F1:2A 250V Fuse The power supply shall be protected against power line surges and any abnormal condition
No Load protection	The power supply is provided with no load operation to prevent the power supply and system from damage.
Protection class	II, (ITU-T K.21 Surge 6KV on request)

CE	
EMC	2014/30/EU
LVD	2014/35/EU EN 60950-1:2006+A11+A1+A12+A2
SAFETY	
CE   GS   cTUVus   FCC   RCM   PSE   EAC   CB	
OTHERS	
Dielectric Strength (Hi-pot)	I/P-O/P:3000VAC
M.T.B.F	500,000 Calculated Hours at 25°C, by Telcordia SR-332
Cable Length	1370mm (4.5 feet) standard cable or as required
PLD (power line disturbance)	Line power surge   Line voltage SAG-more info on request
Cooling method	Natural Convection Cooling
Housing material	PC + ABS
Temperature coefficient:	<±0.5%/°C
ENVIRONMENT	
Temperature	Operating: 0~40°C / Storage: -20~85°C
Humidity	Operating: 8%~90%RH / Storage: 5%~95% RH non condensing
WEIGHT	
NW:	240g/pc + plug
GW:	255g/pc + plug
PACKING	
Box	75 pcs/1 box

**Mechanical case specification:**

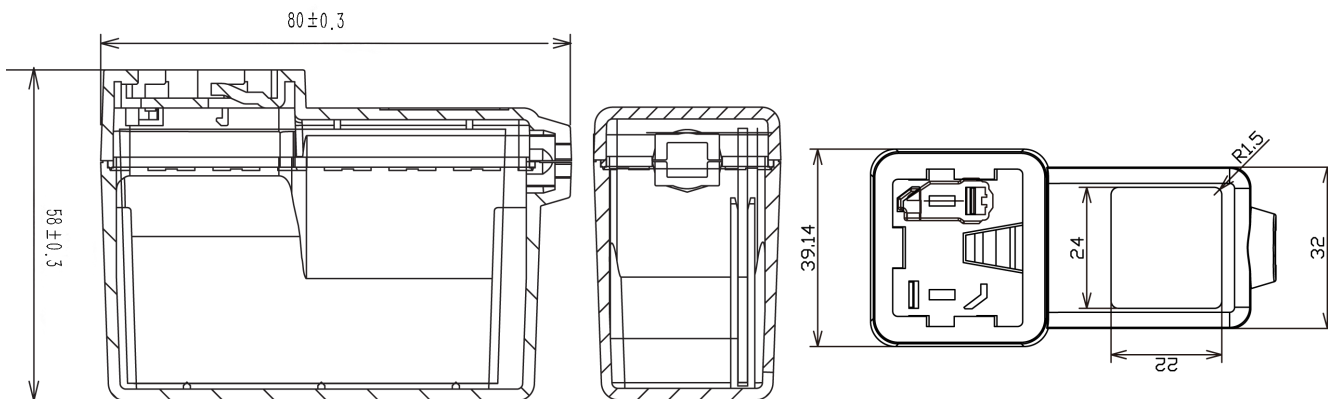

**Mechanical specification (country housing):**

US / Japan type (W2)

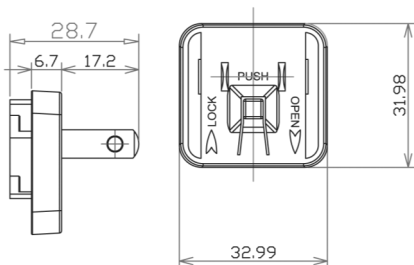

UK type (W3U)

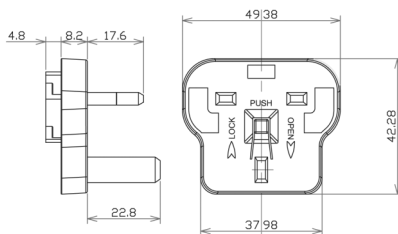

Europe type (W2E)

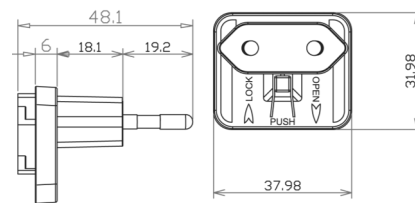

Australia type (W2A)

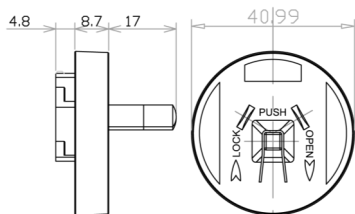

China type (W2C)

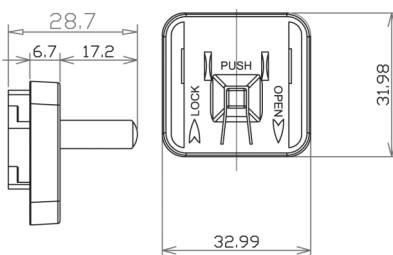

Korea type (W2K)

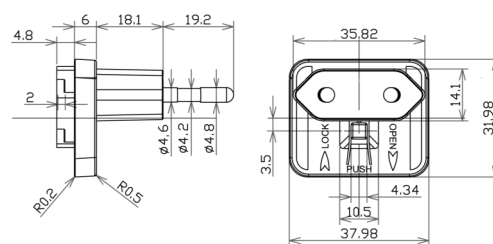

**Cable specification:**

for model SYS1588-3612

2468#18AWG\*2C|1370mm (wire cable)

for model SYS1588-3634

2468#20AWG\*2C|1370mm (wire cable)

